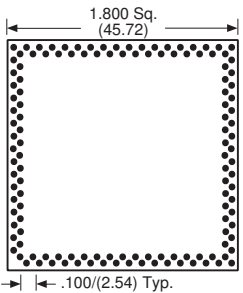
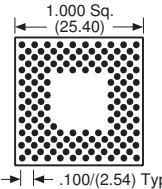
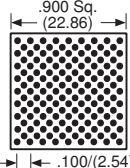
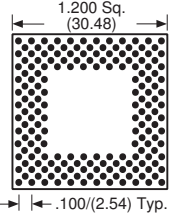
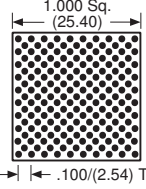
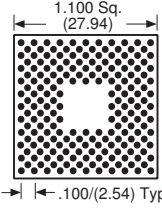
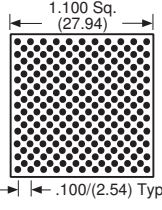
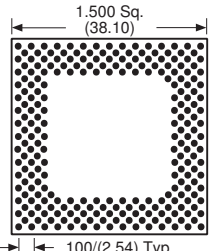
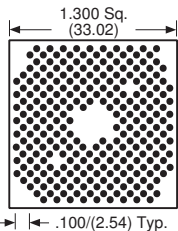
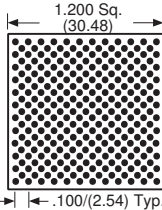
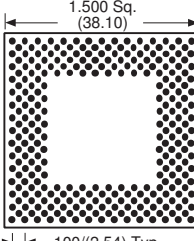
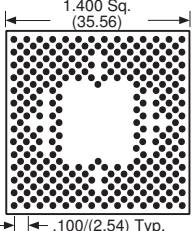

.100/(2.54mm) Pitch Staggered (Interstitial) PGA Socket Footprints

PGA Footprints

<p>131 Pins Footprint Number 131</p>  <p>1.800 Sq. (45.72)</p> <p>→ ← .100/(2.54) Typ.</p> <p>35 x 35 rows</p>	<p>141 Pins Footprint Number 141</p>  <p>1.000 Sq. (25.40)</p> <p>→ ← .100/(2.54) Typ.</p> <p>19 x 19 rows</p>	<p>145 Pins Footprint Number 145</p>  <p>.900 Sq. (22.86)</p> <p>→ ← .100/(2.54) Typ.</p> <p>17 x 17 rows</p>	<p>180 Pins Footprint Number 180</p>  <p>1.200 Sq. (30.48)</p> <p>→ ← .100/(2.54) Typ.</p> <p>23 x 23 rows</p>
---	---	--	---

<p>181 Pins Footprint Number 181</p>  <p>1.000 Sq. (25.40)</p> <p>→ ← .100/(2.54) Typ.</p> <p>19 x 19 rows</p>	<p>196 Pins Footprint Number 196</p>  <p>1.100 Sq. (27.94)</p> <p>→ ← .100/(2.54) Typ.</p> <p>21 x 21 rows</p>	<p>221 Pins Footprint Number 221</p>  <p>1.100 Sq. (27.94)</p> <p>→ ← .100/(2.54) Typ.</p> <p>21 x 21 rows</p>	<p>243 Pins Footprint Number 243</p>  <p>1.500 Sq. (38.10)</p> <p>→ ← .100/(2.54) Typ.</p> <p>29 x 29 rows</p>
--	--	--	--

<p>256 Pins Footprint Number 256-2</p>  <p>1.300 Sq. (33.02)</p> <p>→ ← .100/(2.54) Typ.</p> <p>25 x 25 rows</p>	<p>265 Pins Footprint Number 265</p>  <p>1.200 Sq. (30.48)</p> <p>→ ← .100/(2.54) Typ.</p> <p>23 x 23 rows</p>	<p>276 Pins Footprint Number 276</p>  <p>1.500 Sq. (38.10)</p> <p>→ ← .100/(2.54) Typ.</p> <p>29 x 29 rows</p>	<p>280 Pins Footprint Number 280</p>  <p>1.400 Sq. (35.56)</p> <p>→ ← .100/(2.54) Typ.</p> <p>27 x 27 rows</p>
---	---	---	---



**ADVANCED
INTERCONNECTIONS®**

5 Energy Way, West Warwick, RI 02893 USA
Tel: 800.424.9850 | 401.823.5200
Fax: 401.823.8723
info@advanced.com | www.advanced.com

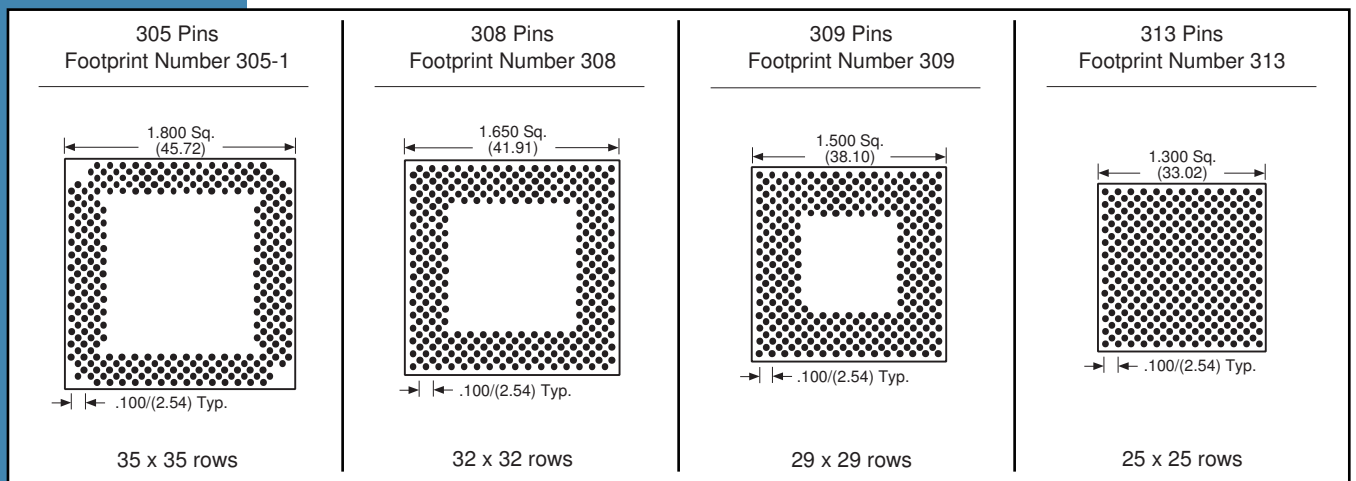
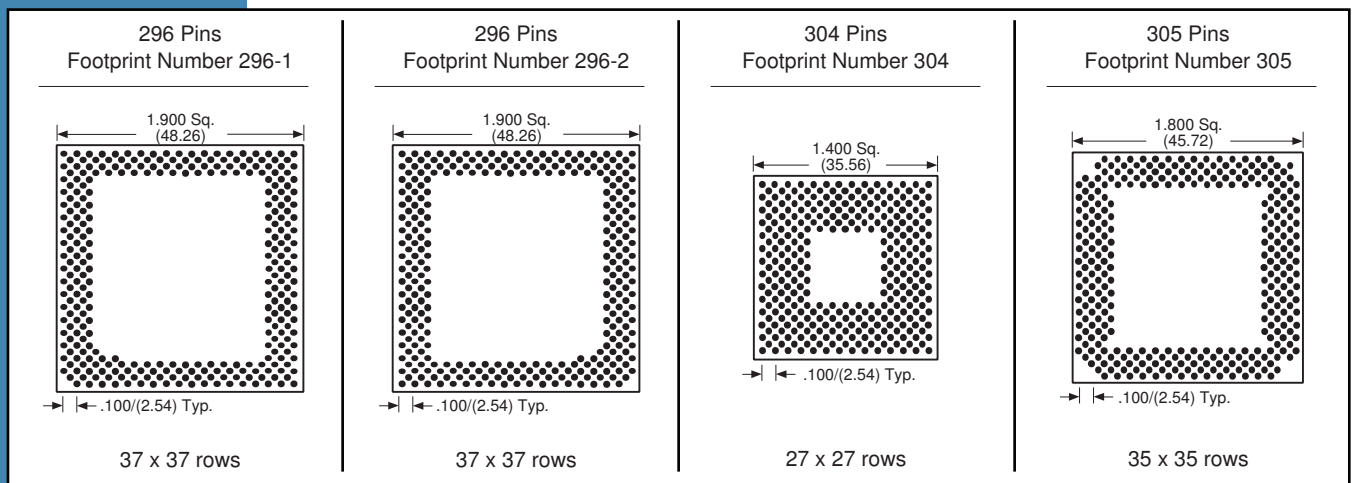
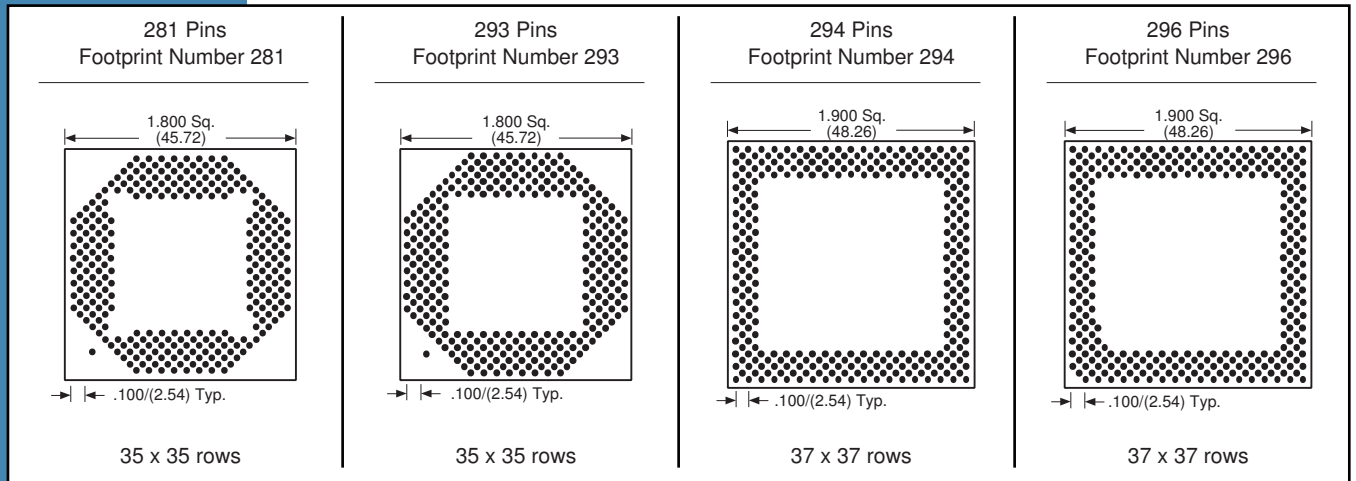

.100/(2.54mm) Pitch Staggered (Interstitial) PGA Socket Footprints

PGA Footprints

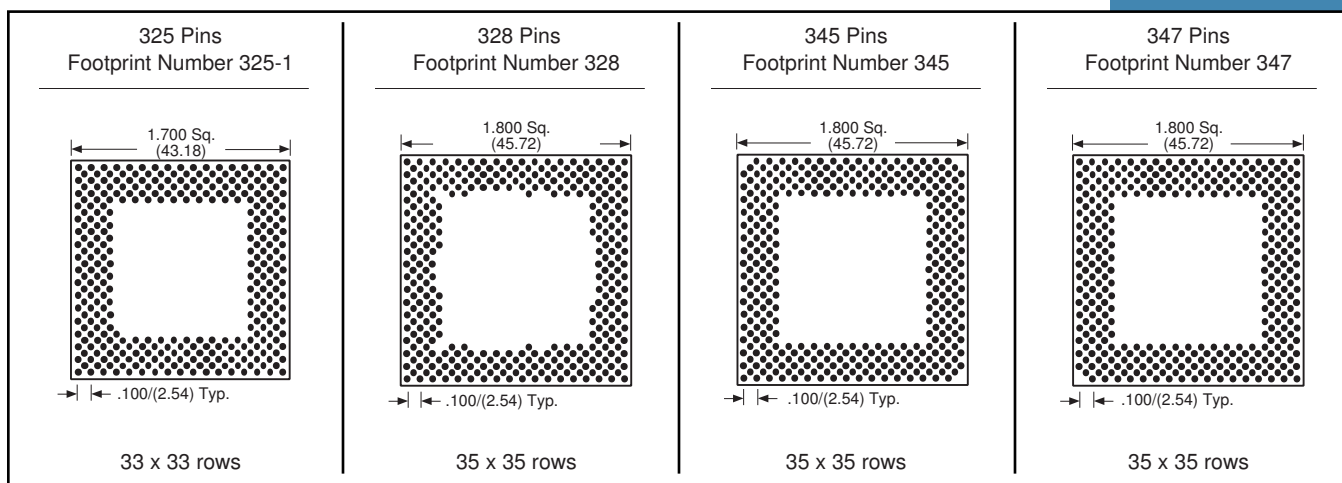
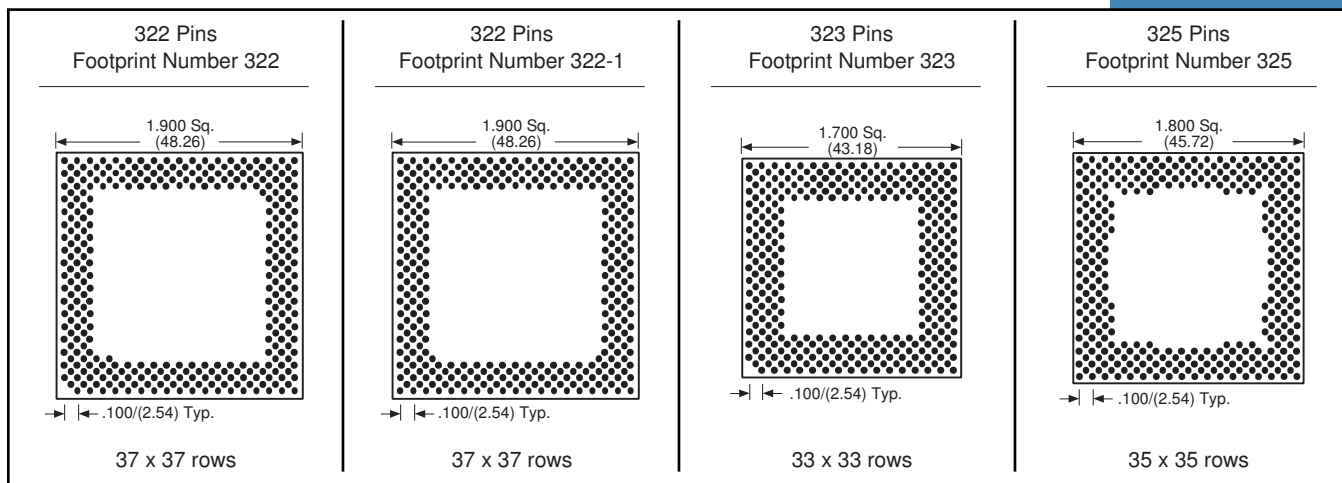
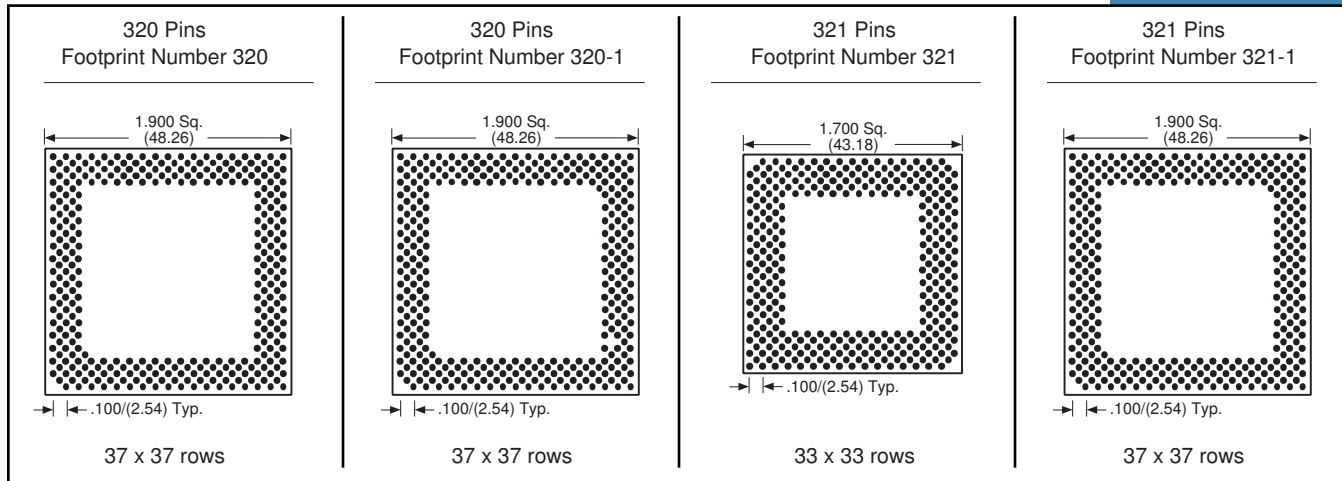

ADVANCED
INTERCONNECTIONS®

5 Energy Way, West Warwick, RI 02893 USA
Tel: 800.424.9850 | 401.823.5200
Fax: 401.823.8723
info@advanced.com | www.advanced.com

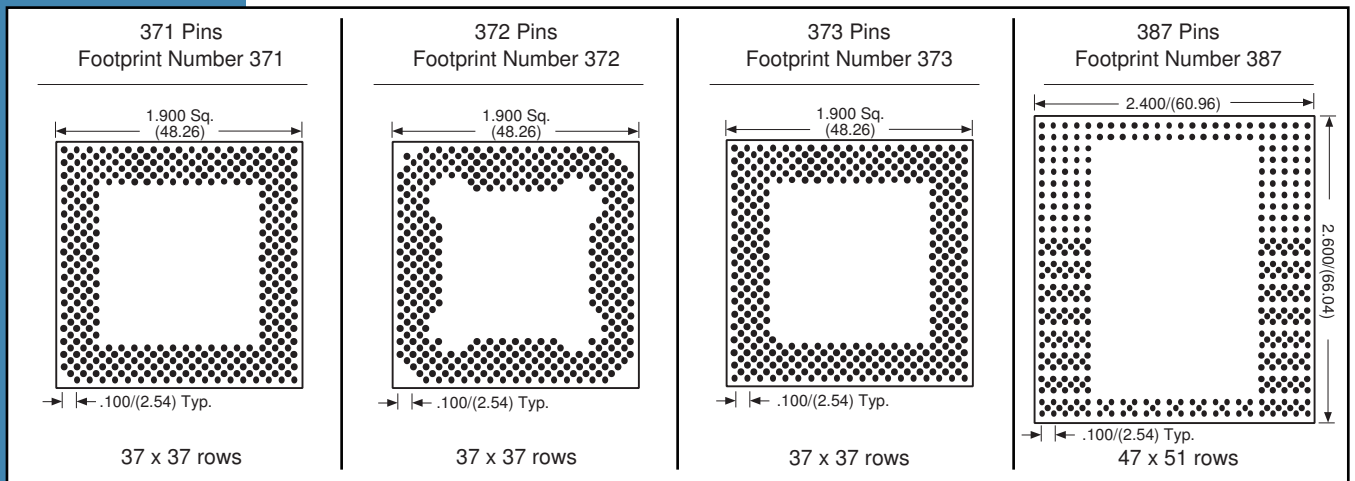
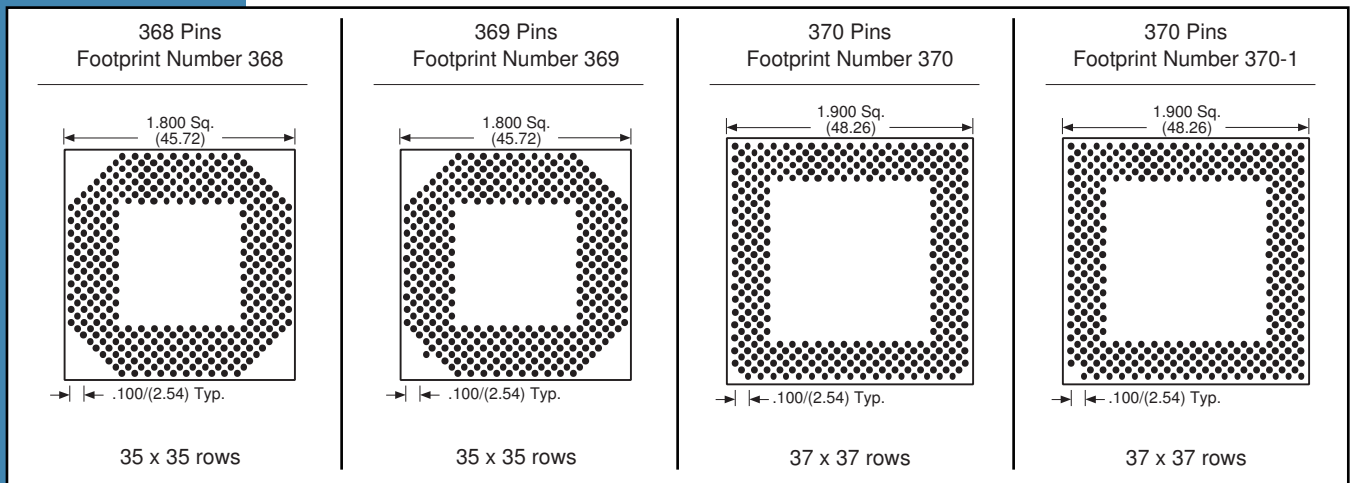
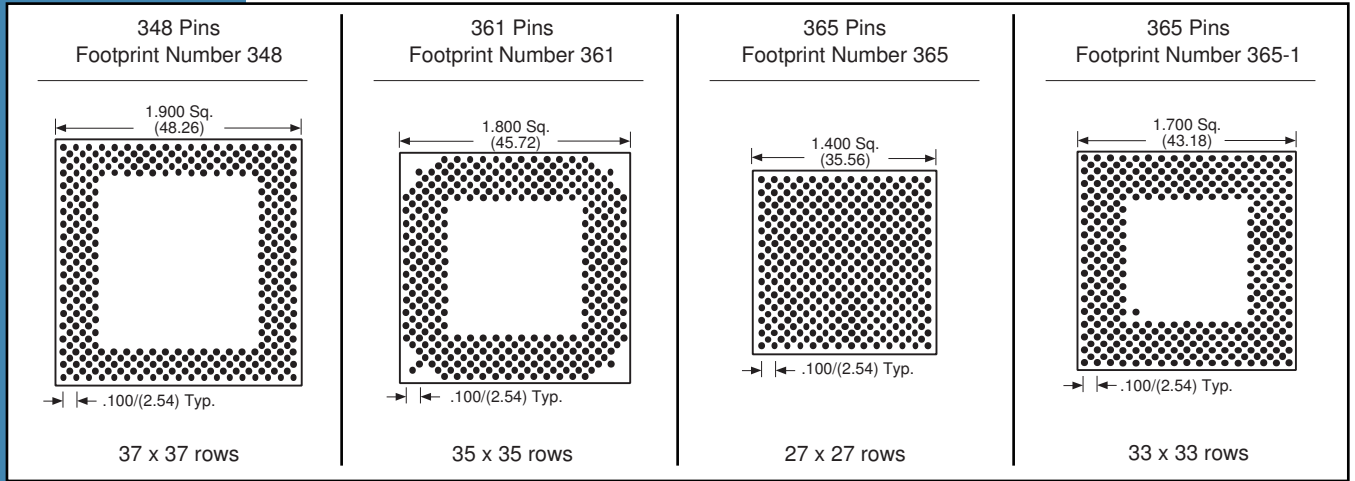

.100/(2.54mm) Pitch Staggered (Interstitial) PGA Socket Footprints

PGA Footprints

<p>389 Pins Footprint Number 389</p> <p>1,700 Sq. (43.18)</p> <p>→ ← .100/(2.54) Typ.</p> <p>33 x 33 rows</p>	<p>391 Pins Footprint Number 391</p> <p>1,800 Sq. (45.72)</p> <p>→ ← .100/(2.54) Typ.</p> <p>35 x 35 rows</p>	<p>391 Pins Footprint Number 391-1</p> <p>1,800 Sq. (45.72)</p> <p>→ ← .100/(2.54) Typ.</p> <p>35 x 35 rows</p>	<p>400 Pins Footprint Number 400</p> <p>1,700 Sq. (43.18)</p> <p>→ ← .100/(2.54) Typ.</p> <p>33 x 33 rows</p>
--	--	--	--

<p>401 Pins Footprint Number 401</p> <p>1,900 Sq. (48.26)</p> <p>→ ← .100/(2.54) Typ.</p> <p>37 x 37 rows</p>	<p>401 Pins Footprint Number 401-1</p> <p>1,900 Sq. (48.26)</p> <p>→ ← .100/(2.54) Typ.</p> <p>37 x 37 rows</p>	<p>403 Pins Footprint Number 403</p> <p>1,900 Sq. (48.26)</p> <p>→ ← .100/(2.54) Typ.</p> <p>37 x 37 rows</p>	<p>404 Pins Footprint Number 404</p> <p>1,900 Sq. (48.26)</p> <p>→ ← .100/(2.54) Typ.</p> <p>37 x 37 rows</p>
--	--	--	--

<p>411 Pins Footprint Number 411</p> <p>2,000 Sq. (50.80)</p> <p>→ ← .100/(2.54) Typ.</p> <p>39 x 39 rows</p>	<p>415 Pins Footprint Number 415</p> <p>1,900 Sq. (48.26)</p> <p>→ ← .100/(2.54) Typ.</p> <p>37 x 37 rows</p>	<p>421 Pins Footprint Number 421</p> <p>1,500 Sq. (38.10)</p> <p>→ ← .100/(2.54) Typ.</p> <p>29 x 29 rows</p>	<p>423 Pins Footprint Number 423</p> <p>2,000 Sq. (50.80)</p> <p>→ ← .100/(2.54) Typ.</p> <p>39 x 39 rows</p>
--	--	--	--



ADVANCED
INTERCONNECTIONS®

5 Energy Way, West Warwick, RI 02893 USA
Tel: 800.424.9850 | 401.823.5200
Fax: 401.823.8723
info@advanced.com | www.advanced.com

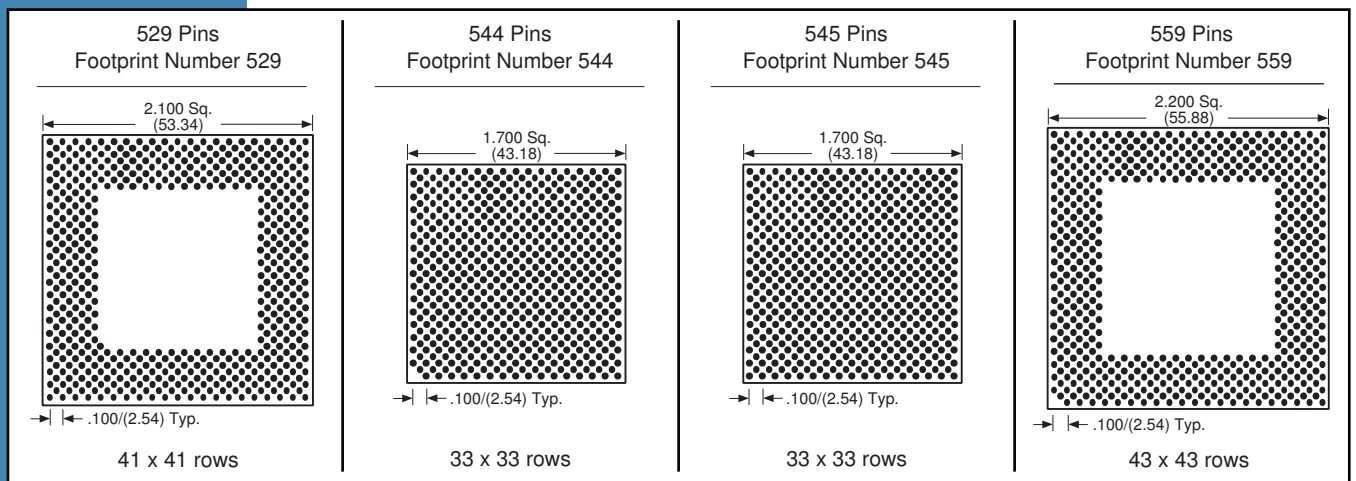
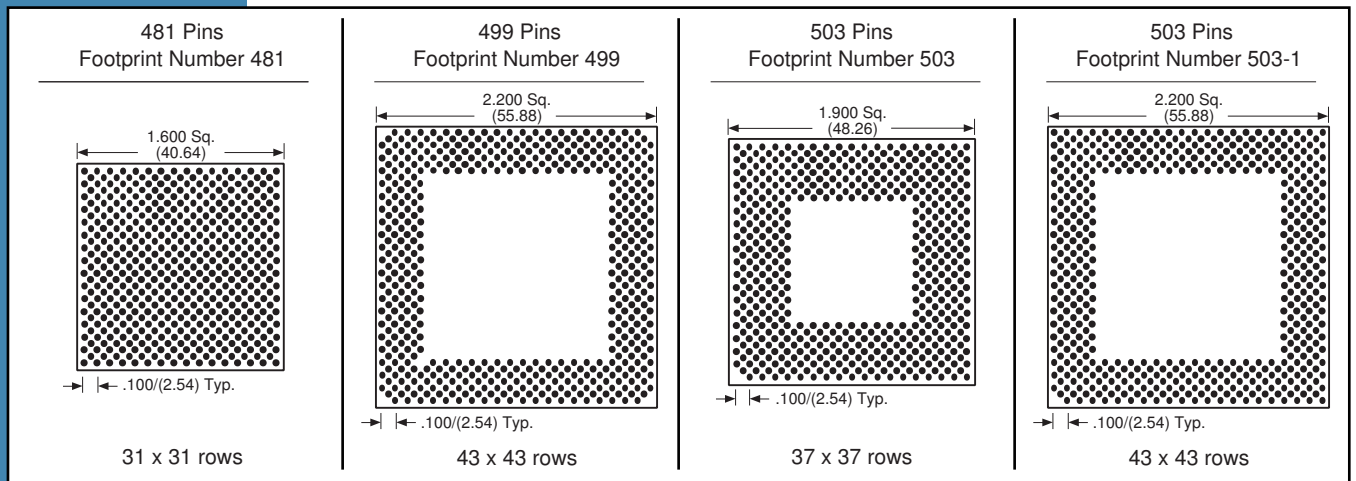
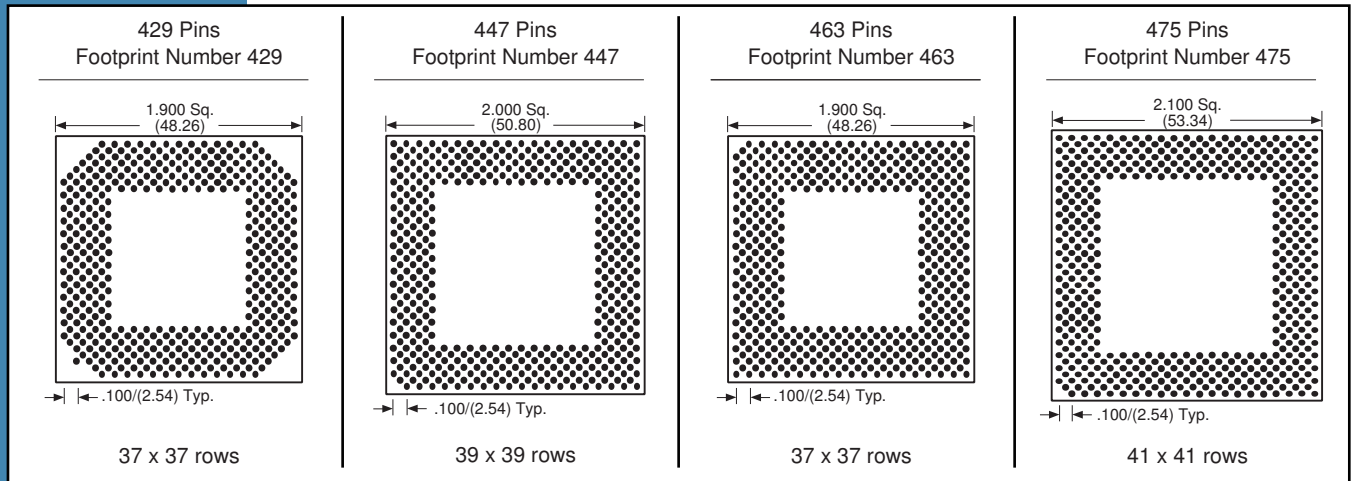

.100/(2.54mm) Pitch Staggered (Interstitial) PGA Socket Footprints

PGA Footprints

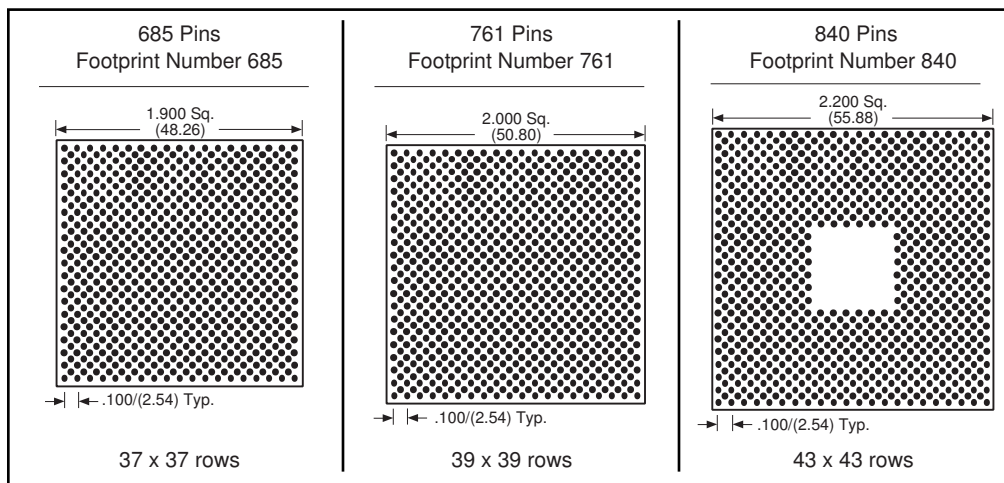
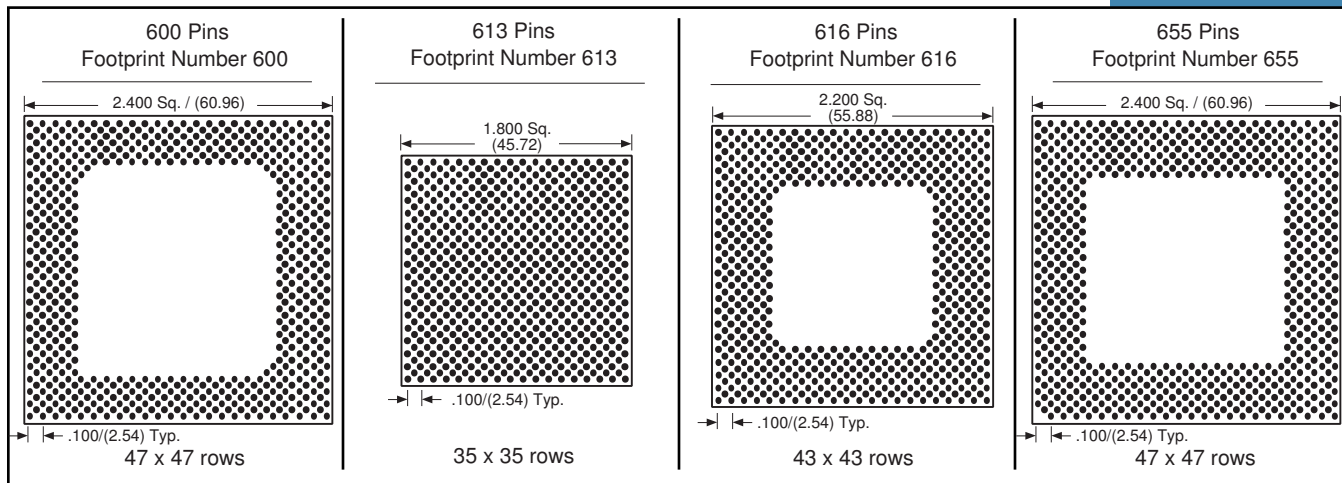
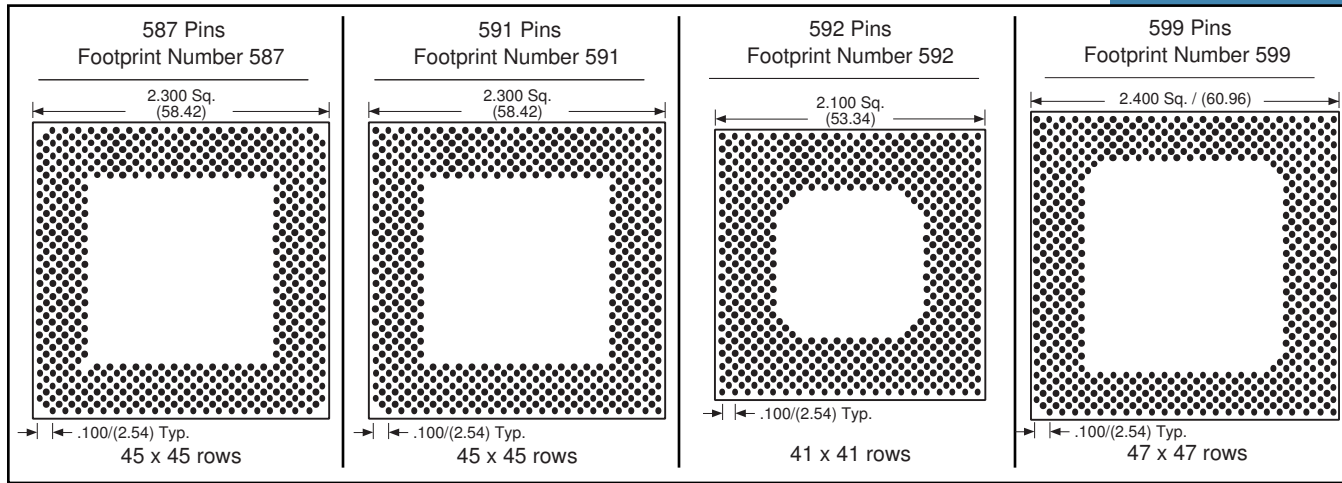

ADVANCED
INTERCONNECTIONS®

5 Energy Way, West Warwick, RI 02893 USA
Tel: 800.424.9850 | 401.823.5200
Fax: 401.823.8723
info@advanced.com | www.advanced.com